

# **Outdoor Network PTZ Dome Cameras**

## Quick Guide

Thank you for purchasing our product. If there are any questions, or requests, please do not hesitate to contact the dealer.

## Copyright

Copyright 2015 Zhejiang Uniview Technologies Co., Ltd. All rights reserved. No part of this manual may be copied, reproduced, translated, or distributed in any form or by any means without prior consent in writing from our company.

## Trademark Acknowledgement

 and other Uniview's trademarks and logos are the property of Zhejiang Uniview Technologies Co., Ltd. Other trademarks, company names and product names contained in this manual are the property of their respective owners.

## Disclaimer



---

### CAUTION!

The default password is used for your first login. To ensure account security, please change the password after your first login. You are recommended to set a strong password (no less than eight characters).

---

- To the maximum extent permitted by applicable law, the product described, with its hardware, software, firmware and documents, is provided on an "as is" basis.
- Best effort has been made to verify the integrity and correctness of the contents in this manual, but no statement, information, or recommendation in this manual shall constitute formal guarantee of any kind, expressed or implied. We shall not be held responsible for any technical or typographical errors in this manual. The

contents of this manual are subject to change without prior notice. Update will be added to the new version of this manual.

- Use of this manual and product and the subsequent result shall be entirely on your own responsibility. In no event shall we be reliable to you for any special, consequential, incidental, or indirect damages, including, among others, damages for loss of business profits, business interruption, or loss of data or documentation, or product malfunction or information leakage caused by cyber attack, hacking or virus in connection with the use of this product.
- Video and audio surveillance can be regulated by laws that vary from country to country. Check the law in your local region before using this product for surveillance purposes. We shall not be held responsible for any consequences resulting from illegal operations of the device.
- The illustrations in this manual are for reference only and may vary depending on the version or model. As a result, some of the examples and functions featured may differ from those displayed on your monitor.
- This manual is a guide for multiple product models and so it is not intended for any specific product.
- Due to uncertainties such as physical environment, discrepancy may exist between the actual values and reference values provided in this manual. The ultimate right to interpretation resides in our company.



## **Environmental Protection**

This product has been designed to comply with the requirements on environmental protection. For the proper storage, use and disposal of this product, national laws and regulations must be observed.



# Safety and Compliance Information

## Safety Symbols

The symbols in the following table may be found on installation-related equipment. Be aware of the situations indicated and take necessary safety precautions during equipment installation and maintenance.

Symbol	Description
	Generic alarm symbol: To suggest a general safety concern.
	ESD protection symbol: To suggest electrostatic-sensitive equipment.
	Electric shock symbol: To suggest a danger of high voltage.

The symbols in the following table may be found in this manual. Carefully follow the instructions indicated by the symbols to avoid hazardous situations and use the product properly.

Symbol	Description
 <b>WARNING!</b>	Indicates a hazardous situation which, if not avoided, could result in bodily injury or death.
 <b>CAUTION!</b>	Indicates a situation which, if not avoided, could result in damage, data loss or malfunction to product.
 <b>NOTE!</b>	Indicates useful or supplemental information about the use of product.

## Safety Information

Installation and removal of the unit and its accessories must be carried out by qualified personnel. Please read all of the safety instructions below before installation and operation.

### Installation

- This device is a class A product and may cause radio interference. Take measures if necessary.

- If the product does not work properly, please contact your dealer. Never attempt to disassemble the camera yourself. (We shall not assume any responsibility for problems caused by unauthorized repair or maintenance.)
- Avoid squashing, shaking, or damping the camera during transport, storage, and mounting. Keep away from vibration sources during mounting.
- Mount the camera outdoors, and protect camera connectors with effective waterproof, moisture-proof, and dust-proof solutions. Screws at connectors must be tightened to entirely seal the camera. For lightning protection, you may mount the lightning arrester.
- When mounting the camera, fasten the tail cable unit and the adapter, after properly securing the adapter and the bracket in place, otherwise, the tail cable could be damaged or water could intrude into the camera.
- Do not straightly look into output interfaces of components with light sources, such as the fiber pin section, optical module, and optical splitter.
- Verify that the length of the cable between the power adapter and the camera does not exceed 1.5 m. If the power cable is longer than 1.5 m, the voltage of the camera is lowered, causing the camera to work improperly. If it is required to lengthen the power cable, lengthen the cable between the power adapter and the mains.
- Disconnect power before moving the camera. Once the cable is connected to the mains, the camera will be powered.
- Do not hold the tail cable by hand for weight bearing. Otherwise, the cable connector of the camera could be loosened.
- Do not cut the tail cable. A bare tail cable may easily cause a short circuit, resulting in abnormality of or damage to the camera.

- Use the waterproof tapes to protect the end of tail cable, and keep the tail cable from water.
- When connecting to an external interface, use an existing connection terminal, and ensure that the cable terminal (latch or clamp) is in good condition and properly fastened. Ensure that the cable is not tense during mounting, with a proper margin reserved to avoid poor port contact or loosening caused by shock or shake.
- Make sure the power supply voltage is correct before using the camera.
- To keep the dome clean, do not remove the protective film on the outer layer of the housing during mounting. After finishing the mounting, remove the film before you power on the camera.
- As is often the case in the industry, dome housings tend to carry static electricity. To avoid dust absorption caused by static electricity, it is recommended to clean the dome housing with antistatic gloves after removing the protective film.
- Power off the camera before cleaning the housing, wipe the internal and outside surfaces using soft dry cloth. Do not use liquid or aerosol cleaners.
- Avoid letting the lens focus on bright-light objects, especially the sun or other bright-light sources. Otherwise, the imaging sensor of the camera may be completely broken.
- Do not touch sensor modules with fingers. If cleaning is necessary, use a clean cloth with a bit of ethanol and wipe it gently. If the camera will not be used for an extended period of time, put on the lens cap to protect the sensor from dirt.
- Do not aim the camera lens at the strong light such as sun or incandescent lamp. The strong light can cause fatal damage to the camera.

- The sensor may be burned out by a laser beam, so when any laser equipment is being used, make sure that the surface of the sensor not be exposed to the laser beam.

### **Maintenance**

- If there is dust on the front glass surface, remove the dust gently using an oil-free brush or a rubber dust blowing ball.
  - If there is grease or a dust stain on the front glass surface, clean the glass surface gently from the center outward using anti-static gloves or an oil-free cloth. If the grease or the stain still cannot be removed, use anti-static gloves or an oil-free cloth dipped with detergent and clean the glass surface gently until it is removed.
  - Do not use organic solvents, such as benzene or ethanol when cleaning the front glass surface.
- 



### **WARNING!**



- Never look at the transmit laser while the power is on. Never look directly at the fiber ports and the fiber cable ends when they are powered on.
  - Use of controls or adjustments to the performance or procedures other than those specified herein may result in hazardous laser emissions.
- 

## **Regulatory Compliance**

### **FCC Part 15**

This equipment has been tested and found to comply with the limits for digital device, pursuant to part 15 of the FCC Rules. These limits are designed to provide reasonable protection against harmful interference when the equipment is operated in a commercial environment. This

equipment generates, uses, and can radiate radio frequency energy and, if not installed and used in accordance with the instruction manual, may cause harmful interference to radio communications. Operation of this equipment in a residential area is likely to cause harmful interference in which case the user will be required to correct the interference at his own expense.

This product complies with Part 15 of the FCC Rules. Operation is subject to the following two conditions:

1. This device may not cause harmful interference.
2. This device must accept any interference received, including interference that may cause undesired operation.

### **LVD/EMC Directive**



This product complies with the European Low Voltage Directive 2006/95/EC and EMC Directive 2004/108/EC.

### **WEEE Directive–2002/96/EC**



The product this manual refers to is covered by the Waste Electrical & Electronic Equipment (WEEE) Directive and must be disposed of in a responsible manner.



# Contents

---

<b>1 Appearance Description.....</b>	<b>1</b>
Dimensions and Appearance .....	1
Cable Connection .....	2
Local Storage Function.....	4
<b>2 Mount Your Camera .....</b>	<b>4</b>
Preparations.....	5
Check Before Mount.....	5
Cable Requirements .....	6
Process Map .....	10
Hardware Installation .....	11
Insert the SD Card (Optional).....	11
Mount the SFP Optical Module (For Certain Models) .....	14
Wall Mount.....	15
Pendant Mount.....	23
Corner Mount .....	28
Standing Pole Mount .....	30
Pole Mount .....	34
Start the Camera.....	36
Reset the Camera to Default Settings.....	36
Waterproof Measures.....	37
Waterproof Components for an RJ45 Plug.....	37
Waterproof Tail Cable.....	39
<b>3 Set Your Camera over the LAN .....</b>	<b>41</b>
<b>4 Access Your Camera.....</b>	<b>42</b>
System Requirements for Your PC.....	42
Access Your Camera.....	43

Install the ActiveX .....	43
Adjust the Display .....	44

# 1 Appearance Description

---

## Dimensions and Appearance

The appearance of different cameras may vary, depending on your camera model. The figures in the manual are for your reference only. For the actual appearance, see the camera.

**Figure 1-1** Front View of a Standard PTZ Dome Camera

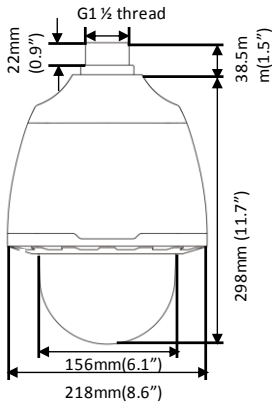

**Figure 1-2** Front View of an All-Weather PTZ Dome

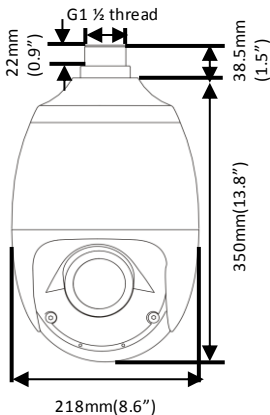

**Figure 1-3** Front View of an Infrared/Laser PTZ Dome

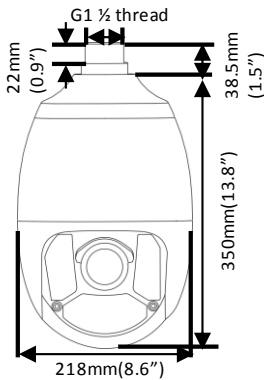

## Cable Connection

All cables are tagged to indicate their functions. This section uses one model as an example. Connect cables by referring to [Table 1-1](#).



### NOTE!

- Certain models support optical interface (SFP module) and FC fiber connector (fiber optical adapter included).
- The dome camera is delivered without the SFP optical module installed. For the details about mounting the optical module, see [Mount the SFP Optical Module \(For Certain Models\)](#).
- Please disconnect the power before mounting. You can connect the camera to the network through the optical interface or the copper interface after mounting and switch two interfaces without disconnecting the power. The two interfaces cannot be used at the same time.
- For the detailed information about the specifications, see the datasheet.

**Figure 1-4 Cable Connection**

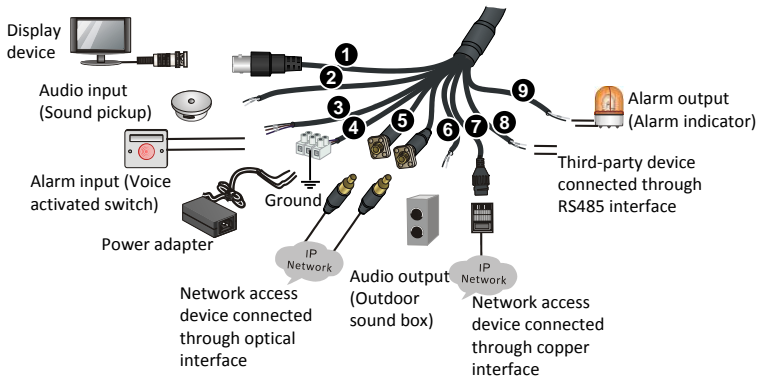

**Table 1-1 Description about Interfaces of Full Tail Cable**

No.	Interface	Function
①	VIDEO OUT	Video output interface. Connect to analog devices such as monitors for video display.
②	AUDIO IN	Audio input interface. Input audio signals or performs intercom. <b>Note:</b> This interface can be used in either audio input or intercom.
③	ALARM IN	Alarm input interface. Input alarm signals.
④	Power interface	Connect the power adaptor.
⑤	Ethernet optical interface	100M/1000M Base-FX adaptive SFP optical module. Connect to the optical interface network.
⑥	AUDIO OUT	Output audio signals.
⑦	Ethernet copper interface	Connect to the network.
⑧	RS485	Interact and control an external device. For example, it can control a third-party device.

No.	Interface	Function
9	ALARM OUT	Output alarm signals.

## Local Storage Function

---



### NOTE!

- The camera supports one SD card for local storage. Please choose a proper SD card. For details about recommended SD card specifications, contact your dealer.
  - To use the local storage function, remove the housing first, and then insert the SD card into the slot. For the detailed operations, see [Insert the SD Card \(Optional\)](#).
- 

To use the local storage function, format the SD card before use. You can do the format job in the software interface.

With the SD card installed, the local storage function automatically starts in about 15 seconds after the central storage fails.

Data stored in the SD card will be overwritten when the SD card is full. Therefore, you need to export the data in time, or use video upload function to backup video. The backup process is controlled by the backup server managed by the central server. Backup video can be played on the web interface of the central server.

## 2 Mount Your Camera

---

This chapter takes the procedure for mounting a standard PTZ dome as an example. The mounting procedures for other models are similar so the specific differences are described in this manual.

# Preparations

## Check Before Mount

**Figure 2-1** Check camera components.

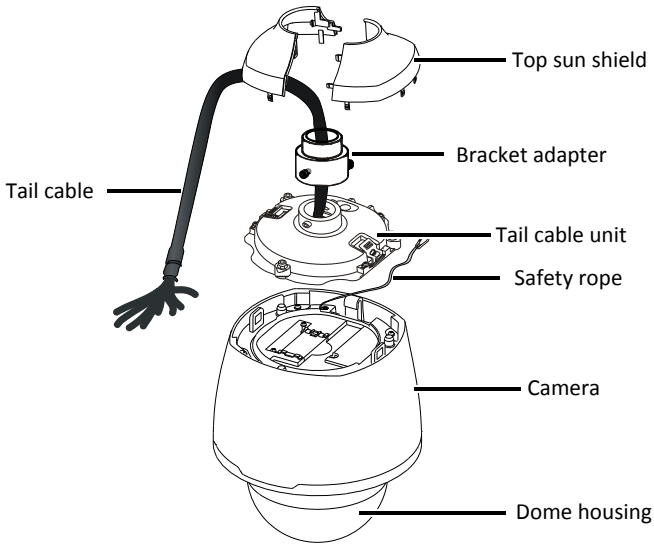

Compared with the standard PTZ dome, the all-weather, infrared, and laser PTZ domes have different camera designs and no housing. However, other components are the same.

### **Verify the bearing capacity of the mounted position.**

Verify that the mounted position meets the bearing requirements. Otherwise, it is recommended to reinforce the mounted position for the camera weight. For more information, see the product datasheet.

### **Verify the lightning protection and grounding requirements.**

- Select proper lightning protection devices for the power supply, audio and video interfaces, and RS485 interfaces.
- Refer to [Table 2-2](#) to ground the terminal properly.

## Cable Requirements

### Network cable

10/100 Mbps Ethernet CAT5 UTP cables are applicable to the ANSI/EIA/TIA-568A/B and ISO/D.

Eight wires in the network cable need to be inserted in parallel into the top of the cable connector. The cable connector needs to be crimped in position. When the cable connector is in position, ensure that the metal pieces of the cable connector are parallel to each other and the clamp of the cable connector is intact.

### Optical fiber

The optical module in the camera should match that of the third-party device (such as a switch), in terms of fiber mode and emission/receiver wavelength. Ensure the transmission distance of the optical module is greater than the distance actually required.



---

#### **NOTE!**

For a dome camera with optical module, it should be connected to the single mode optical fiber instead of multimode optical fiber.

---

Ensure that the following requirements are satisfied when connecting two devices using an optical fiber:

- When an SFP optical module is connected, the curvature of the optical fiber should be greater than 90 degrees.



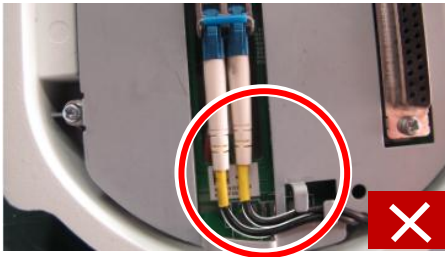
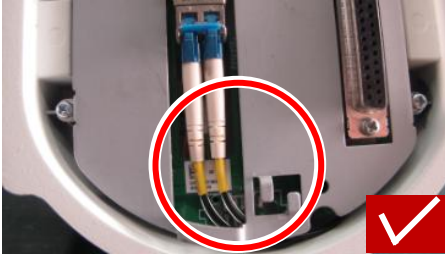

- When mounting the tail cable unit, ensure that the optical fiber is not clamped by the camera. Otherwise, the optical fiber could be damaged.
- Do not bend the optical fiber excessively during mounting. If the optical fiber is too long, coil the optical fiber. Ensure that the coil diameter is greater than 60 mm and the curvature is greater than 90 degrees.



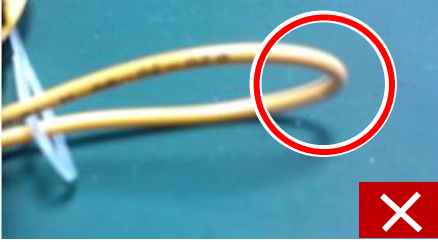

- Select a high-quality fiber connector. If a non-standard fiber connector without chamfering is used, internal ceramic sleeves such as the optical module, flange, or optical splitter could be damaged.
- Ensure that the fiber connector is in good condition, the latch is not disrupted and keeps elasticity, and the connection to the peer end is normal.

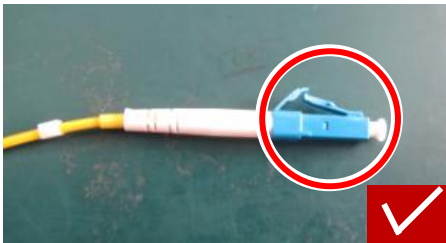

- Before connecting an optical fiber, check that there is no obvious surface defect such as stain, scratch, dent, or pit. If the fiber connector, flange, or optical module is dirty, clean it with alcohol and clean cotton (or a clean cotton rod).
- When using an optical fiber to connect the camera, if a flange is required for connecting the fiber connector, determine the model of the flange according to the type of the fiber connector on the peer device first, or perform cascading by directly using an optical splitter.
- When using a fiber connector to interconnect with a flange, aim the fiber connector at the slot of the flange so as to ensure proper interconnection.



**Power cable**



**NOTE!**

Data listed in [Table 2-1](#) is applicable to copper cables that use 24 VAC /24 VDC power supply. The item Core Diameter indicates the conductor diameter.

**Table 2-1** Power Loss on the Cable for Different Lengths and Different Core Diameters

Distance (Unit: m)	Core Diameter (Unit: mm)			
	0.80	1.00	1.25	2.00
Power (Unit: W)				
30	28	45	72	183
40	21	34	54	137
50	17	27	43	110
60	-	22	36	91
70	-	19	31	78
80	-	-	27	68

Core Diameter (Unit: mm)	0.80	1.00	1.25	2.00
90	-	-	24	61
100	-	-	21	55

**Table 2-2** Phoenix Terminal for the Power Cable

Power Supply	Cable Color
24 VAC 3A 24 VDC 2.5A	+ / -: The anode and the cathode are not distinguished for the red and black cables.
	<b>GND:</b> yellow-green, used to ground the camera. <b>Note:</b> Ensure that the terminal is connected to a reliable grounding point.

## Process Map

Make sure the camera is disconnected from the power during installation.



### NOTE!

- Accessories such as the wall mount bracket and the pendant mount bracket may be necessary during mounting. For supported models, refer to the recommended list provided by your dealer.
- The wall bearing capacity and the bracket length must satisfy mounting requirements. Select a proper mount mode according to the actual situations.

**Figure 2-2 Mounting Process**

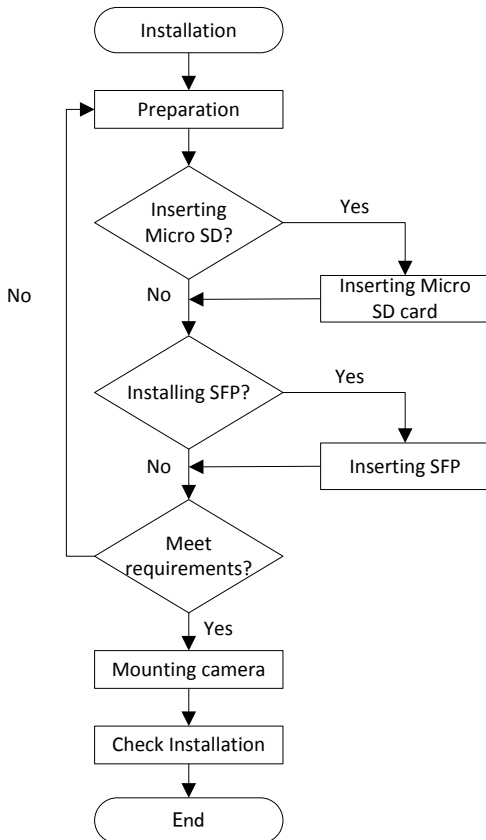

## Hardware Installation

### Insert the SD Card (Optional)

To use the local storage function, you need to install a Micro SD card or SD card first. The SD card is installed inside the camera. To install the SD card, you need to remove the housing first. Do not hot plug the Micro SD card after it is inserted. Otherwise the camera or the SD card might be damaged.

**NOTE!**

For details about recommended SD card specifications, contact your dealer.

---

**Standard PTZ Dome**

1. Unscrew the five inner hexagon screws, and remove the dome housing.

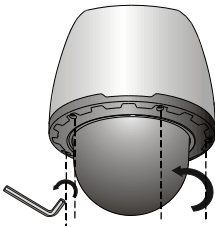

2. Insert the SD card and reinstall the housing.

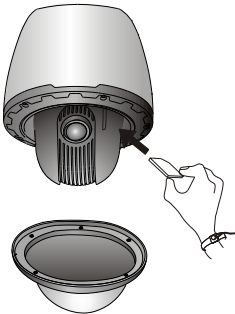

### All-Weather PTZ Dome

1. Unscrew the four inner hexagon screws, and remove the front cover.

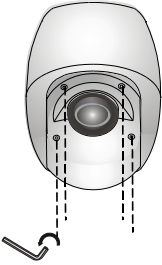

2. Insert the SD card and reinstall the front cover.

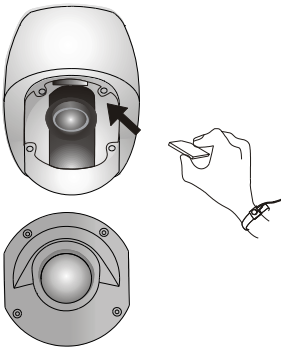

### Infrared/Laser PTZ Dome

1. Unscrew the four inner hexagon screws, and remove the front cover.

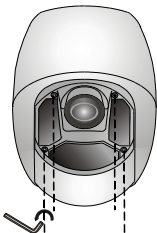

2. Insert the SD card and reinstall the front cover.

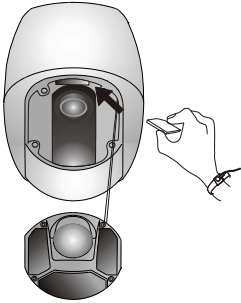

## Mount the SFP Optical Module (For Certain Models)



### NOTE!

- Select the optical module by referring to the recommended list.
- During connection, ensure that the optical fiber plug of the optical module matches the optical interface of the tail cable. You may refer to information on the label attached to each optical interface.

1. Remove the dustproof cover inside the tail cable unit.

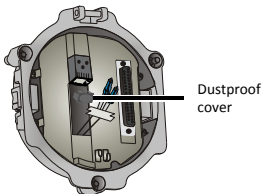

2. Insert the SFP optical module recommended by your dealer.

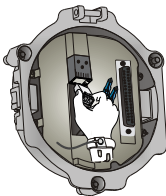



3. Connect the optical fiber plug and the optical module.

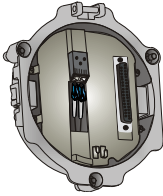

## Wall Mount

Fast mount and conventional mount are basically the same. The difference lies in operations after Step 5. Fast mount avoids weight lifting and allows one to finish the mounting job.

This section describes both fast mount and conventional mount for wall mount. For other mount modes, only fast mount is described.

---



### CAUTION!

- When mounting the camera, please install the bracket adapter to the bracket first and then mount the camera to the bracket.
  - Pay attention to the three stainless screws that connect the tail cable unit and the camera. Verify that they are tightened so that the camera is entirely sealed. Ensure that the sun shield on the tail cable unit is mounted in position.
  - Fasten the screws of various joints connecting to the dome camera, such as the bracket and the adapter ring, and ensure that no screws are missing.
  - For waterproofing, apply sealant between the dome and the bracket, wall veneer slits, and leading-out holes of the wall.
  - The following section describes concealed installation. To implement open installation, directly lead the cable out of the leading-out hole on the flank of the bracket.
-

## Fast Mount

1. Locate the positions of the holes.
  - a. Mark the positions of the holes by referring to the mount points of the bracket.
  - b. Lead the cables to be connected out of wall holes.

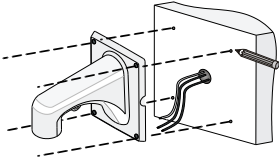

2. Drill holes on the wall.

Select a drill bit matching the outer diameter of the expansion bolt.  
For the hole depth, refer to the bolt length.

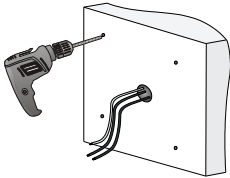

3. Knock the expansion bolts, and verify that they are tightened up.

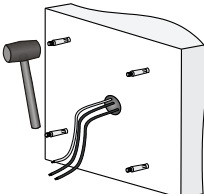

4. Screw-in the bracket adapter (G1 ½ male thread) to the connector of the wall mount bracket.

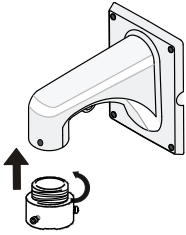

5. Tighten the screws (M4) at the bracket.

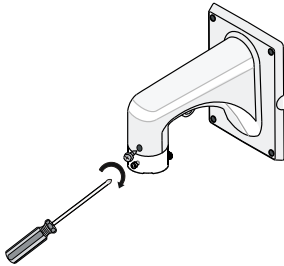

6. Lead the tail cable through the bracket, and push up.

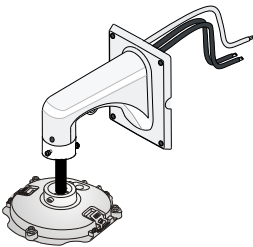

7. Slide the camera holder into the inner track and turn the camera till it is blocked by the bracket adapter screw.

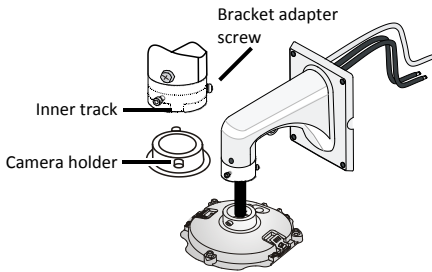

8. Fasten the bracket to the four expansion bolts by using flat washers, spring washers, and nuts.

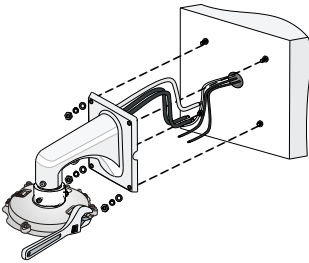

9. Hang one end of the safety rope to the camera and the other to the bracket before mounting the dome.

- 10.** Attach the tail cable unit on the hook with the camera perfectly aligned with the three positioning pilot pillars, push the dome camera in place, and then secure the three stainless screws.

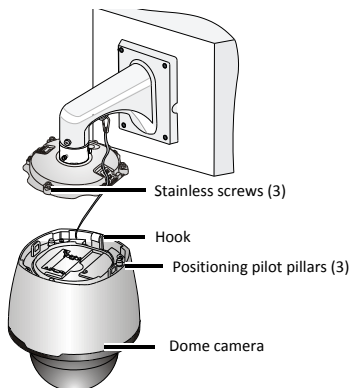

- 11.** Mount the top sun shield.

Combine the left and right halves of the top sun shield by aligning them concurrently with the triangle icon of the dome. Then, attach them downwards on the dome.

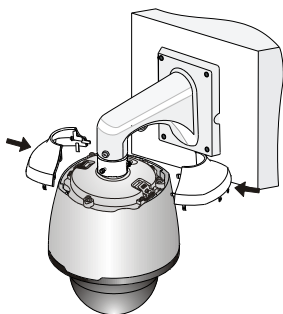

## Conventional Mount

1. Locate the positions of the holes.
  - a. Mark the positions of the holes by referring to the mount points of the bracket.
  - b. Lead the cable through the hole on the wall.

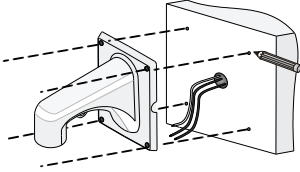

2. Drill holes on the wall.

Select a drill bit matching the outer diameter of the expansion bolt.  
For the hole depth, refer to the bolt length.

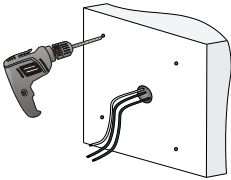

3. Knock the expansion bolts, and verify that they are tightened up.

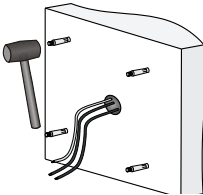

4. Screw-in the bracket adapter (G1 ½ male thread) to the connector of the wall mount bracket.

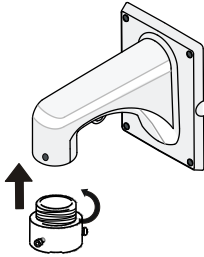

5. Tighten the screws (M4) at the bracket.

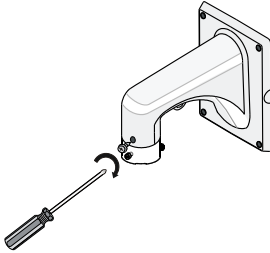

6. Attach the tail cable unit to the hook with the camera perfectly aligned with the three positioning pilot pillars, push the dome camera in place, and then secure the three stainless screws.

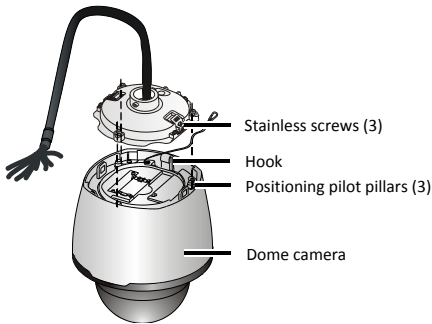

7. Hang the other end of the safety rope on the bracket, lead the tail cable through the bracket, and push up.

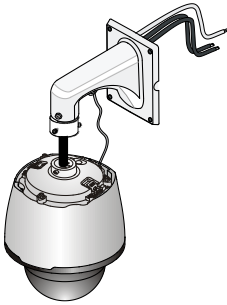

8. Slide the camera holder into the inner track and turn the camera till it is blocked by the bracket adapter screw.

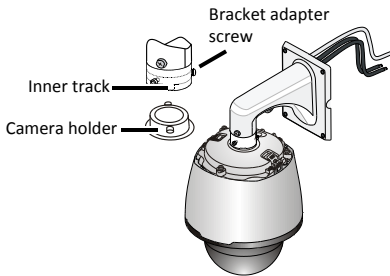

9. Mount the top sun shield. Combine the left and right halves of the top sun shield by aligning them concurrently with the triangle icon of the dome. Then, attach them downwards on the dome.

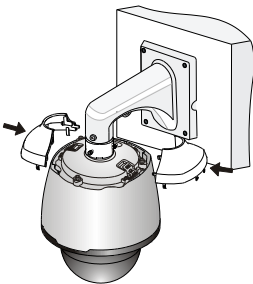



10. Fasten the bracket to the four expansion bolts, and lock the bracket by using flat washers, spring washers, and nuts.

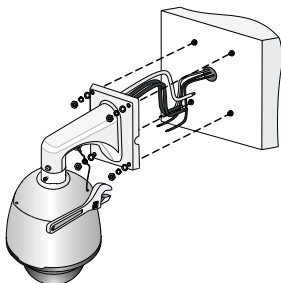

## Pendant Mount

---



### NOTE!

- The pendant mount bracket is for indoor installation only. For specially required outdoor installation, please make sure all waterproof requirements are met. We will not assume any responsibility for damage or loss incurred otherwise.
  - Any custom made pendant must conform to the waterproof requirements.
  - Tail cables should be protected by waterproof measurements and not be exposed. The whole wiring area of tail cables should be well waterproofed. Seal the connector of the dome camera and the pendant for waterproofing. Ensure that the sun shield on the tail cable unit is mounted in position.
  - When mounting the camera, please first install the bracket adapter to the bracket and then mount the tail cable unit to the adapter.
-

1. Locate the positions of the holes.
  - a. Mark the positions of the holes by referring to the mount points of the bracket.
  - b. Lead the cable through the hole on the wall.

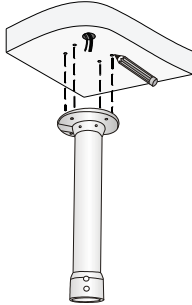

2. Select a drill bit matching the outer diameter of the expansion bolt.  
For the hole depth, refer to the bolt length.

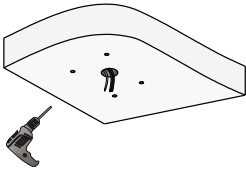

3. Knock the expansion bolts, and verify that they are tightened up.

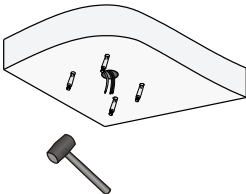

4. Screw-in the bracket adapter (G1 ½ male thread) to the connector of the pendant mount bracket.



5. Tighten the screws (M4) at the bracket.



6. Lead the tail cable through the bracket, and push up.

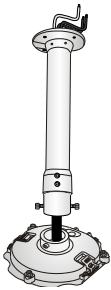

7. Slide the camera holder into the inner track and turn the camera till it is blocked by the bracket adapter screw.

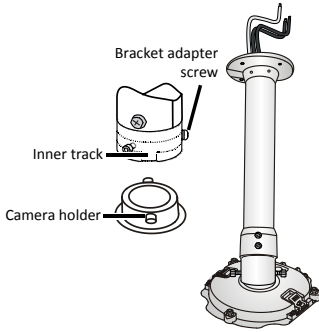

8. Fasten the bracket to the four expansion bolts, and lock the bracket by using flat washers, spring washers, and nuts.

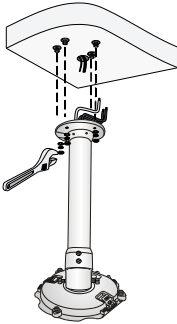

9. Attach the tail cable unit to the hook with the camera perfectly aligned with the three positioning pilot pillars, push the camera into place, and then secure the three stainless screws.

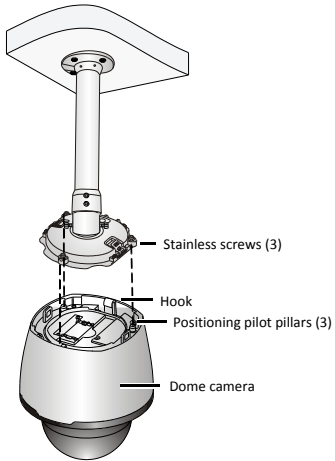

10. Mount the top sun shield.

Combine the left and right halves of the top sun shield by aligning them concurrently with the triangle icon of the dome. Then, attach them downwards on the dome.

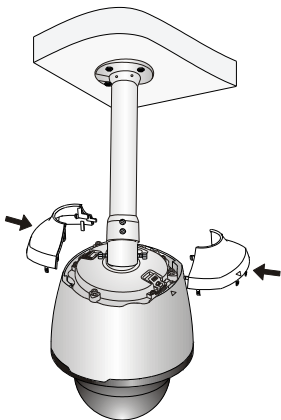



## CAUTION!

- When mounting the camera, please install the bracket adapter to the bracket first and then mount the camera to the bracket.
  - Seal the connector between the dome camera and the pole for waterproofing. Ensure that the sun shield on the tail cable unit is mounted in position.
  - The following section describes concealed installation. To implement open installation, directly lead the cable out of the leading-out hole on the flank of the bracket.
- 

## Corner Mount

1. Mark positions of holes by referring to mount points of the bracket.

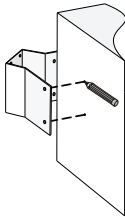

2. Drill holes on the wall.

Select a drill bit matching the outer diameter of the expansion bolt.  
For the hole depth, refer to the bolt length.

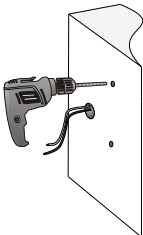

3. Knock the expansion bolts, and verify that they are tightened up.

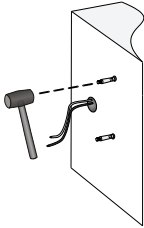

4. Mount the corner mount accessory and lead the cables out.  
Fasten the corner mount accessory to the four expansion bolts, and lock the accessory by using flat washers, spring washers, and nuts.

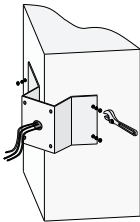

5. Mount the tail cable unit and the wall mount bracket by referring to steps 4 to 7 in [Fast Mount](#).

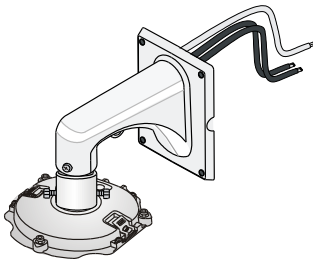

6. Fasten the bracket to the corner mount accessory by using four expansion bolts, and lock the bracket by using flat washers, spring washers, and nuts.

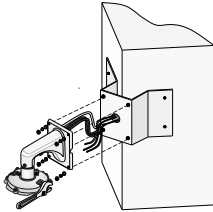

7. Mount the dome and the top sun shield by referring to steps [9](#) to [10](#) in [Fast Mount](#).

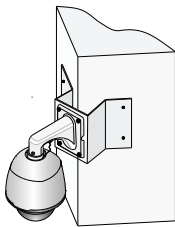

### CAUTION!

- When mounting the camera, please install the bracket adapter to the bracket first and then mount the camera to the bracket.
  - Allow sufficient space for the cables and then tighten the screws. Loose screws may cause the camera to fall.
  - The preceding installation process is concealed installation. To implement open installation, directly lead the cable out of the leading-out hole on the flank of the bracket.
- 

## Standing Pole Mount

Standing pole mount needs no bracket or accessory, and you can directly use an original pole in engineering or a customized pole.



## Using the Original Standing Pole

You need to customize an adapter if the reserved interface of the pole does not match the adapter delivered with the dome.

1. Customize the adapter so that the dome matches with the original standing pole.

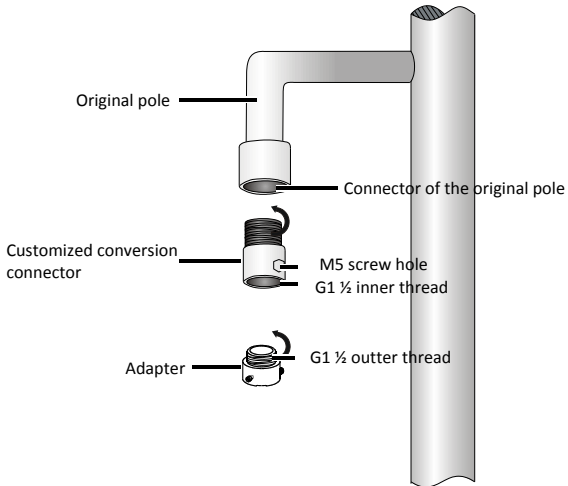

2. Connect and fasten the original standing pole to the two adapters.

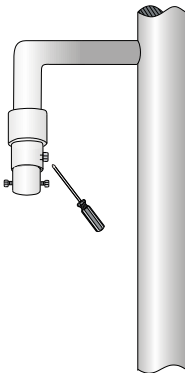

3. Connect the tail cable unit, lead the tail cable into the pole, and connect all cables. See steps [6](#) to [7](#) in [Pendant Mount](#).

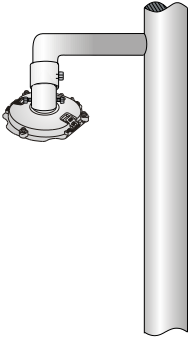

4. Mount the dome and the top sun shield by referring to steps [9](#) to [10](#) in [Pendant Mount](#).

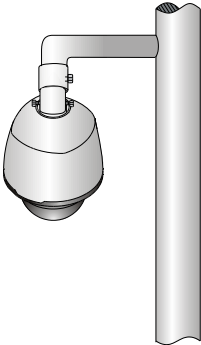

## Customizing the Standing Pole

1. Customize a standing pole to match the dome.

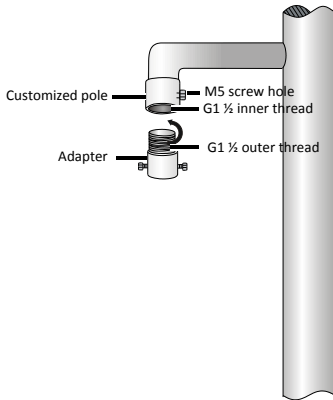

2. Connect and fasten the customized pole to the adapter.

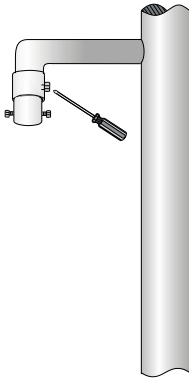

3. Mount the tail cable unit, the dome, and the top sun shield in sequence, same as the operations in [Using the Original Standing Pole](#).



## CAUTION!

- When mounting the camera, please install the bracket adapter to the bracket first and then mount the camera to the bracket.
  - Seal the connector between the dome camera and the pole for waterproofing. Ensure that the sun shield on the tail cable unit is mounted in position.
- 

## Pole Mount

1. Assemble pole mount accessories, loosen the three pole mount clamps, and insert them into holes of the pole mount bracket.

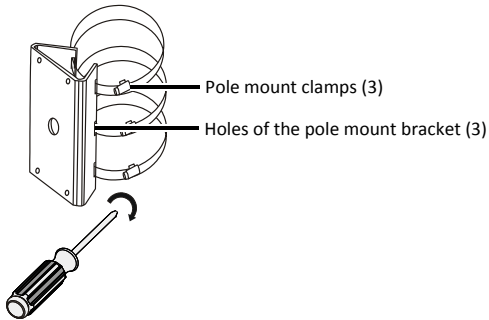

2. Tighten the clamps, and fasten the clamps to the pillar.

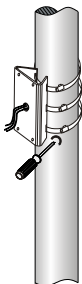

3. Mount the tail cable unit and the wall mount bracket by referring to steps [4](#) to [7](#) in [Fast Mount](#).

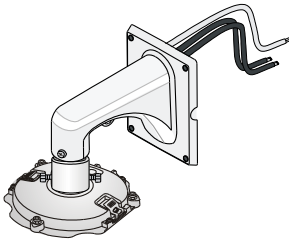

4. Fasten the bracket to the pole mount accessory by using the four expansion bolts, and lock the bracket by using flat washers, spring washers, and nuts.

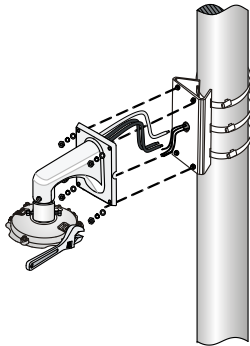

5. Mount the dome and the top sun shield by referring to step [9](#) to [10](#) in [Fast Mount](#).

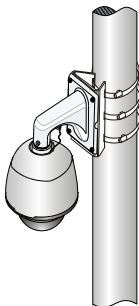



### **CAUTION!**

- When mounting the camera, please install the bracket adapter to the bracket first and then mount the camera to the bracket.
  - When stabilizing the bracket, allow sufficient space for the cables and then tighten the screws. Loose screws may cause the camera to fall.
  - The preceding installation process is about concealed installation. To implement open installation, directly lead the cable out of the leading-out hole on the flank of the bracket.
- 

## Start the Camera

After verifying that the camera is properly mounted, start the camera by connecting it to power.

Each time the camera is powered on, it will perform a self-test to check the Pan/Tilt/Zoom (PTZ) function. After self-test, you can operate the camera.



### **NOTE!**

- The self-test process starts after the camera is powered up. Please wait patiently.
  - When the working temperature is lower than zero Celsius degrees, the camera will be automatically pre-heated. When the temperature rises above zero Celsius degrees, the camera will start the self-test again. It takes a rather long time (at most 30 minutes) for the camera to finish the pre-heating process.
- 

## Reset the Camera to Default Settings

Disconnect the camera from power and then remove the tail cable unit from the camera. For the camera structure, see [Figure 2-1](#). Slide the DIP switch that is shown in the figure below, replace the tail cable unit and then connect the camera to power. The camera is restored to the factory default settings after the startup.



## Waterproof Measures

### Waterproof Components for an RJ45 Plug

1. Attach the seal ring to the copper interface.

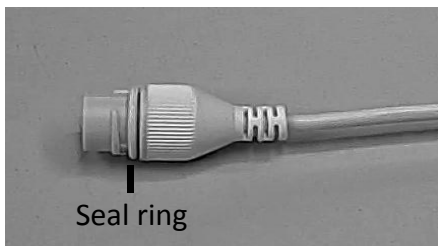

2. Mount the waterproof components.

You can crimp the inner wires of the cable with the RJ45 plug first and then cover the waterproof components. You may also cover the waterproof components first.

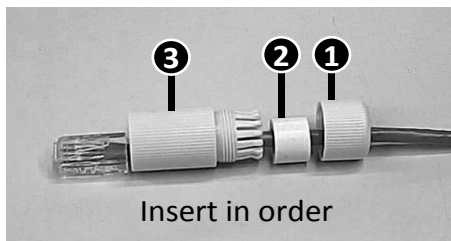

3. Insert the cylindrical waterproof ring into bolt.

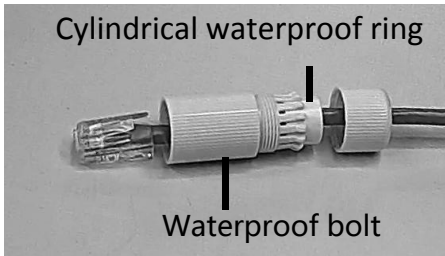

4. Insert the cable into the Ethernet copper interface and screw the waterproof bolt in.

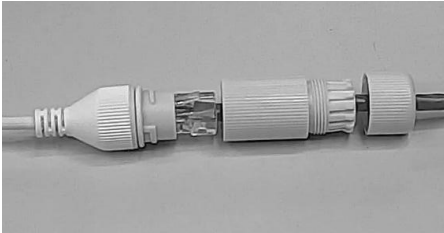

5. Screw in the waterproof bolt lid.

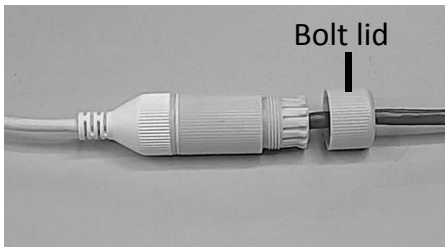



6. Finish the waterproof installation.

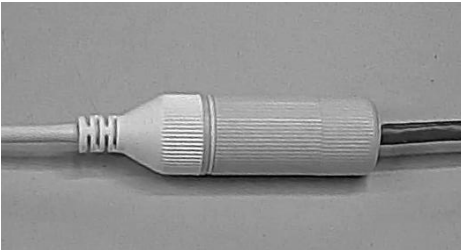

## Waterproof Tail Cable

Connect the tail cables and then take the following steps to protect the tail cables from water using waterproof tapes. The figures are only for illustration purpose.

1. Connect the tail cables.

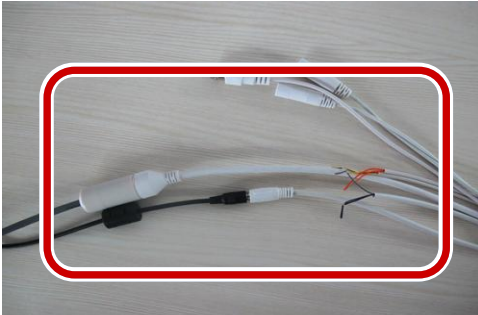

2. Protect the connected cables using insulating tapes.

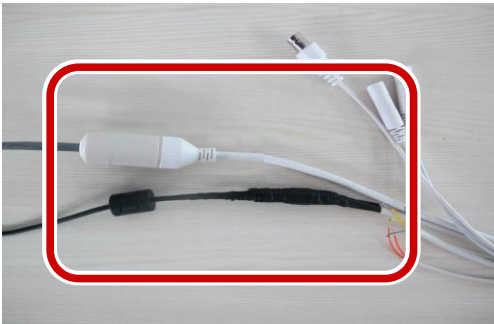

3. Protect other cables using insulating tapes.



4. Wrap all the tail cables together using insulating tapes.



5. Choose a start point for waterproof tapes.



6. Protect the tail cables using waterproof tapes.



#### **CAUTION!**

- Avoid short circuit when insulating the cables.
  - Use self adhesive waterproof tapes that will stick together with the twisted cables.
  - Tighten waterproof tapes when wrapping the cables and make sure the cable connections are fully covered.
  - You are recommended to put the waterproof cables in a waterproof junction box which needs to be purchased separately.
- 

## **3 Set Your Camera over the LAN**

---

To view and configure your camera via the local area network (LAN), you need to install the EZStation to find your camera and change its IP address.

---



#### **NOTE!**

- Please contact your dealer to get EZStation.
  - Please refer to the EZStation user manual for detailed information.
- 

1. Connect your camera and your PC as shown in the figure below to ensure the routing is available.



2. Use EZStation to search online cameras automatically.
3. Modify the camera settings if necessary, including its IP address and subnet mask.



**NOTE!**

- The default IP address is “192.168.0.13”. The default username is “admin” and the default password is “123456”.
- To access your camera from a different subnet, set the gateway for your camera after you log in.

## 4 Access Your Camera

### System Requirements for Your PC

**Table 4-1** PC Requirements

Item	Requirements
Operating system	Microsoft Windows 8/Windows 7/Windows XP (32-bit or 64-bit). Microsoft Windows 7 is recommended.
CPU	2.0 GHz or higher, dual-core. Intel i3 CPU or higher is recommended.
Memory	At least 1 GB. 2 GB (or higher) is recommended.
Graphic card	At least 128MB display memory. Mainstream discrete graphics with more than 1GB display memory are recommended. The hardware should support DirectX9.0c. <b>Note:</b> Make sure that the latest driver is installed on graphic card.
Sound card	Required. <b>Note:</b> Two-way audio and voice broadcast require the latest driver on sound card.
Network	Megabit Ethernet network cards (or higher) are

Item	Requirements
card	recommended.

## Access Your Camera

Before you begin, check that:

- Your camera is operating properly and connected to the network.
- The PC client you are using is installed with Internet Explorer 7.0 or later. IE 8.0 is recommended.

Follow these steps to access your camera through the Web interface:

1. Open your browser, input the IP address of your camera (default IP is 192.168.0.13) in the address bar and then press **Enter** to open the login page.
2. Enter the username (default is “admin”) and password (default is “123456”) and then click **Login**.



### NOTE!

Install the ActiveX at your first login. For the detailed steps, see [Install the ActiveX](#). When the installation of the ActiveX is completed, open your IE to log in.

## Install the ActiveX

The following takes the IE browser as an example to describe the installation steps.

1. Click **Download**.



Failed to load ActiveX control, click [Download](#) to install latest ActiveX control.

2. Click **Run**. You may also click **Save** to download the file to your computer first.

3. Close the browser and follow the steps to complete the installation.
- 



#### **NOTE!**

- For your first login with Windows 7, if the system does not prompt you to install ActiveX, follow these steps to turn off UAC: click the **Start** button, and then click **Control Panel**. In the search box, type **uac**, and then click **Change User Account Control Settings**. Move the slider to the **Never Notify** position, and then click **OK**. After UAC is turned off, log in again.
  - If the installation failed, open **Internet Option** in IE before login. Click the **Security** tab, click **Trusted sites**, and then click **Sites** to add the website. If you use Windows 7, you need to save the setup.exe to your PC first, and then right-click the file, select **Run as administrator**, and then install it according to instructions.
- 

## Adjust the Display

Enter the live view page, and then click the **Zoom** and **Focus** buttons to get clear image.

BOM: 3101COBT